



Kleinschmidt

Empowering a Renewable Energy Future!



We Provide Practical Solutions for Complex Renewable Energy, Water, and Environmental Projects.

For more than 55 years, Kleinschmidt has provided engineering, regulatory, and environmental consulting services to energy companies and government agencies across North America. We provide **practical solutions** to complex problems affecting energy, water and the environment.

We are a mid-size, employee-owned firm offering technical expertise and the skills required to work on **large, complex projects**. We have 12 offices strategically located throughout North America that enable us to provide personal attention and be responsive to our clients.

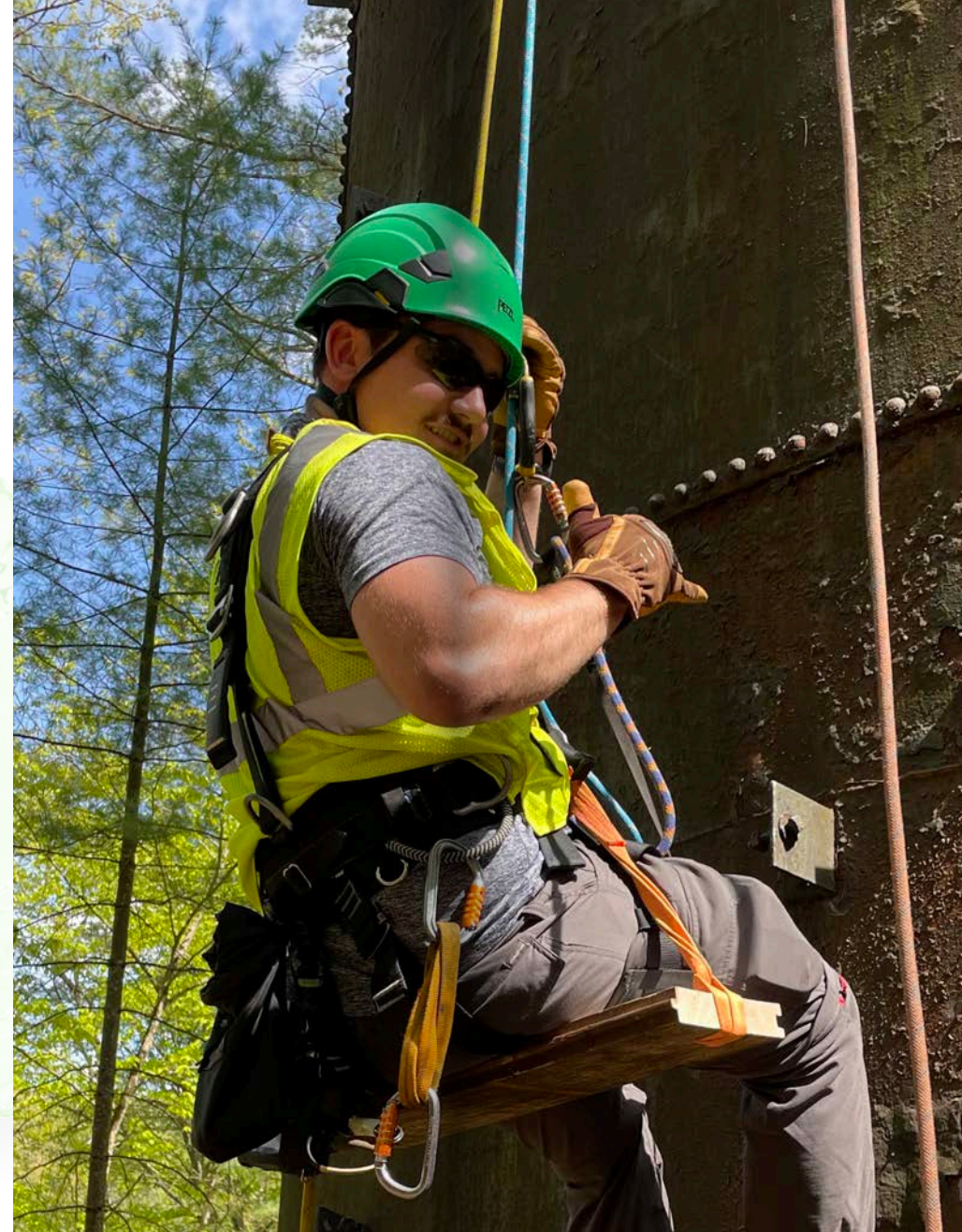

Safety

Kleinschmidt has a formal safety program which includes a corporate safety officer, safety committee, and safety procedures to ensure safe and healthful conditions for all employees. All members of the Kleinschmidt team are required to follow appropriate components of the program and receive annual job-specific training as part of Kleinschmidt's own Safety Week.



Social Impact

At Kleinschmidt, our values guide how we treat each other, serve our clients, perform our work, and serve our communities. We are honored to promote STEM initiatives at local schools and colleges, such as the Kleinschmidt Windstorm Challenge at the University of Maine, and several other robotics and science programs. We assist many other organizations in our communities through meaningful partnerships and employee volunteerism. We are thankful to our socially conscious employees for giving back to the communities where we work, live and play.

We also recognize the importance of Diversity, Equity and Inclusion (DEI), both inside and outside of our organization. We understand and value the business aspects of having diverse perspectives, experiences, and knowledge that allow us to fulfill our mission of doing meaningful work and providing practical solutions to complex problems. To that end, we have worked diligently to team with, and hire subcontractors from economically and socially diverse segments of America's workforce, joining forces with Native American owned, woman owned, minority owned, service-disabled veteran owned and HubZone businesses to deliver great service.

Client Listening Program

Loyal relationships with our clients, teaming partners, and employees is one of our **Core Values** and has been part of our foundation since Steve Kleinschmidt founded us in 1966. Our success over the years has come from taking the time to listen intently and identify our client's underlying needs so we continue to provide value throughout the life cycle of your project.

Always proactive! Keep things on track and on schedule. Very easy to work with. All of the Kleinschmidt team goes 100% to make sure we are getting things done.

— Columbia Basin Hydropower

Just how to do this audit was an unknown. Very little guidance from FERC. But KA came through once again and provided a great product at a reasonable price. Good job!

— Entergy Services, Inc.
Arkansas Carpenter &
Remmell ODSP Audit



Project Manager was easy to work with and communicated well. He is very representative of our overall experience with Kleinschmidt. He is technically proficient AND a practical engineer, the best combination.

— Confidential Client, Georgia

Who We Work For



POWER UTILITIES



INDEPENDENT POWER AND ENERGY DEVELOPERS



GOVERNMENT AND NGO'S



WATER UTILITIES

Kleinschmidt provides engineering, regulatory and environmental services for North American energy companies and governmental agencies who endeavor to **protect and enhance** the natural environment, without compromising performance.

What We Do

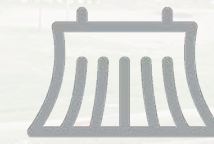

HYDROPOWER ENGINEERING



DAM SAFETY AND WATER INFRASTRUCTURE ENGINEERING

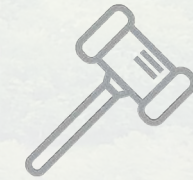

LICENSING AND PERMITTING



ENVIRONMENTAL SERVICES

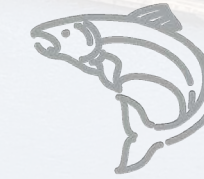

FISHERIES ENGINEERING



WATER RESOURCE ENGINEERING AND HABITAT RESTORATION



GIS, STATISTICS, AND MODELING

We excel in working at the intersection of regulatory requirements, environmental science, and engineering solutions. Kleinschmidt staffs each project with **experienced** and **knowledgeable** personnel to meet the challenges of each project. Our reputation for providing practical solutions to complex problems affecting energy, water and the environment is founded on **50+ years** of experience and our ability to analyze, prepare, and present project information in a logical, thorough, and technically sound manner.

Hydropower Engineering

We have served this market for more than 50 years, working on hundreds of hydropower facilities from existing hydropower **rehabilitations and modernizations**, to building **new facilities**. We build **trust** with our clients by working effectively to solve problems in a manner that reduces costs and increases revenues.

- Feasibility and Planning
- Asset Modernization & New Facility Engineering
- Penstock Inspections & Design
- Valuations and Due Diligence
- Pumped Storage
- Construction Services

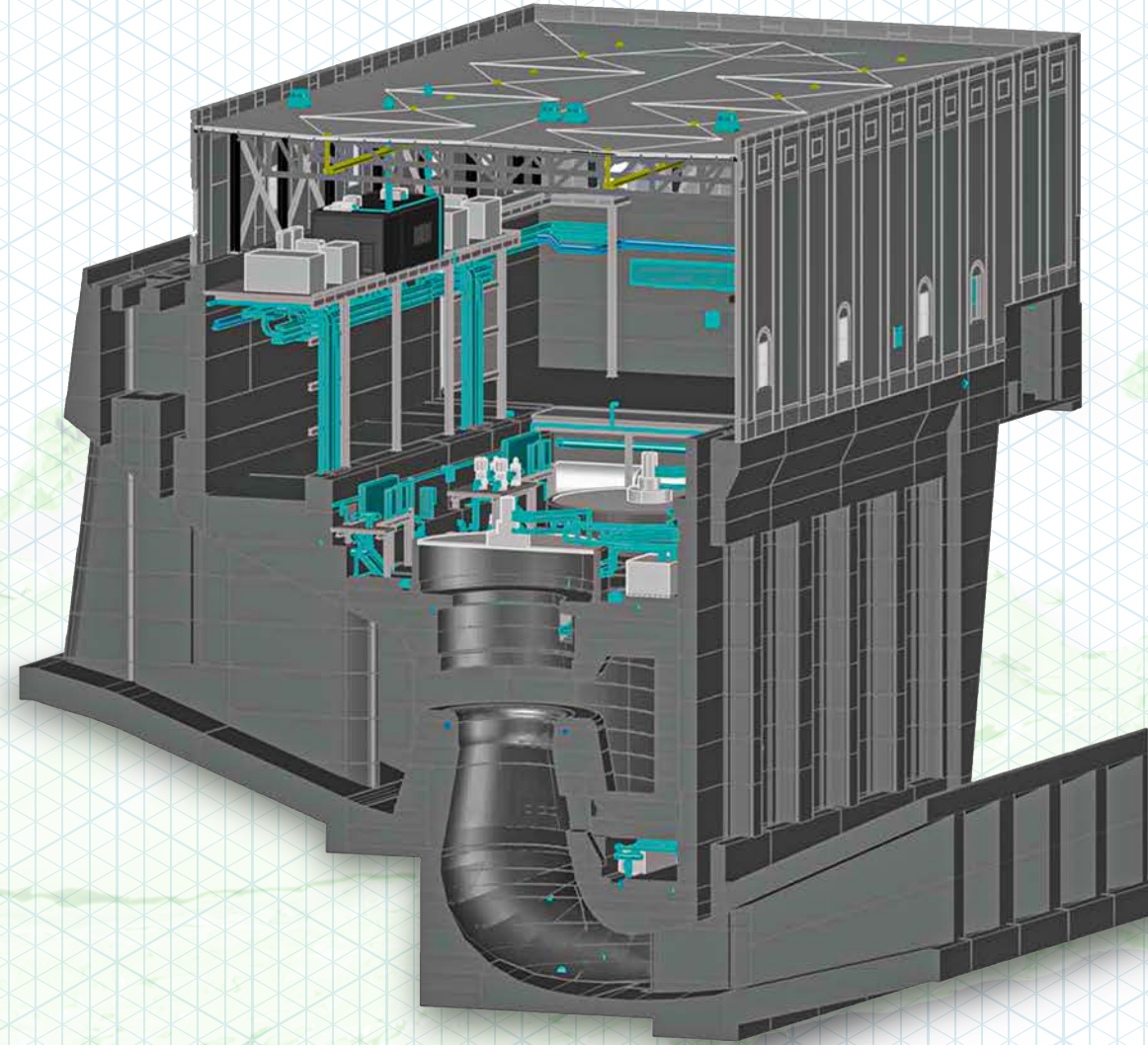
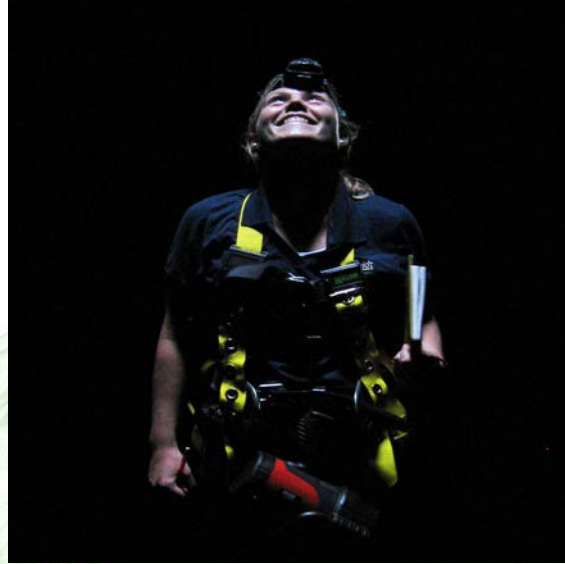

Dam Safety & Infrastructure Engineering

We know dams. Conducting dam safety inspections has been a core competency of Kleinschmidt's since 1966, and in the past 5 years, we have completed more than 200 dam inspection projects. Our dam engineers provide studies, inspections, and designs to meet the needs of today's dam owners. We work with our clients to determine the most **cost-effective** means to help owners ensure the safety of their dams. Our extensive experience in identifying, studying, and preparing solutions to complex dam issues can provide you with **peace of mind** that your project is in the best hands.

- Dam Safety Inspections & Monitoring
- Dam & Spillway Engineering
- Spillway / Gate Inspection & Design
- Emergency Action Plans & Dam Breach Analysis

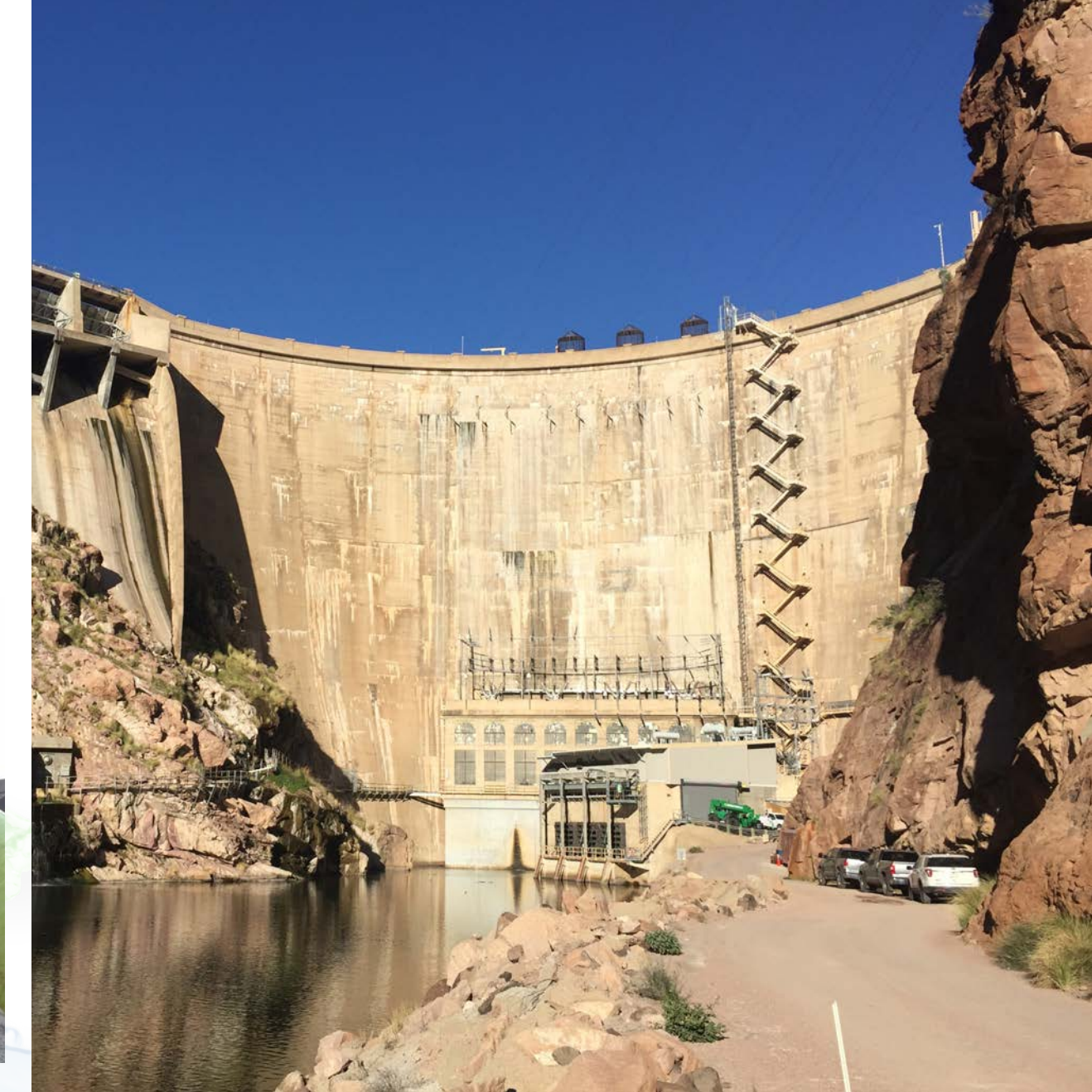



Licensing and Permitting

Many of our clients experience frustration due to the complicated, bureaucratic nature of government regulations. Trying to sort through regulatory agency jurisdictions and their requirements, regardless of the project size or complexity, is often characterized as a daunting task. We have been helping companies like yours **navigate** the regulatory process for more than 4 decades and this is an area where **experience matters!** Our experience has helped companies save millions of dollars.

- Federal/State/Provincial Permitting & Approvals
- FERC Licensing
- NEPA
- Regulatory Compliance & Reporting



Environmental Services

Kleinschmidt has 40+ years of experience helping clients create sustainable solutions to complex land and water resource issues. We have become highly regarded for ecosystem assessments, individual habitat and river restoration projects, watershed management, water supply reservoir management, dam removal, fish passage, and impact studies for wetlands. Our success lies in our commitment to integrating science, planning, and engineering disciplines. By offering the biologist, the engineer, and the planner as part of one integrated team, we **save** clients time and money, and we create **lasting** solutions that benefit the environment.

- Wetland & Habitat Investigations
- Stream Flow Regulation Studies
- Fisheries & Aquatic Organism Assessments
- Steam Electric 316(a) & (b) Compliance
- Rare, Threatened, & Endangered Species Assessments

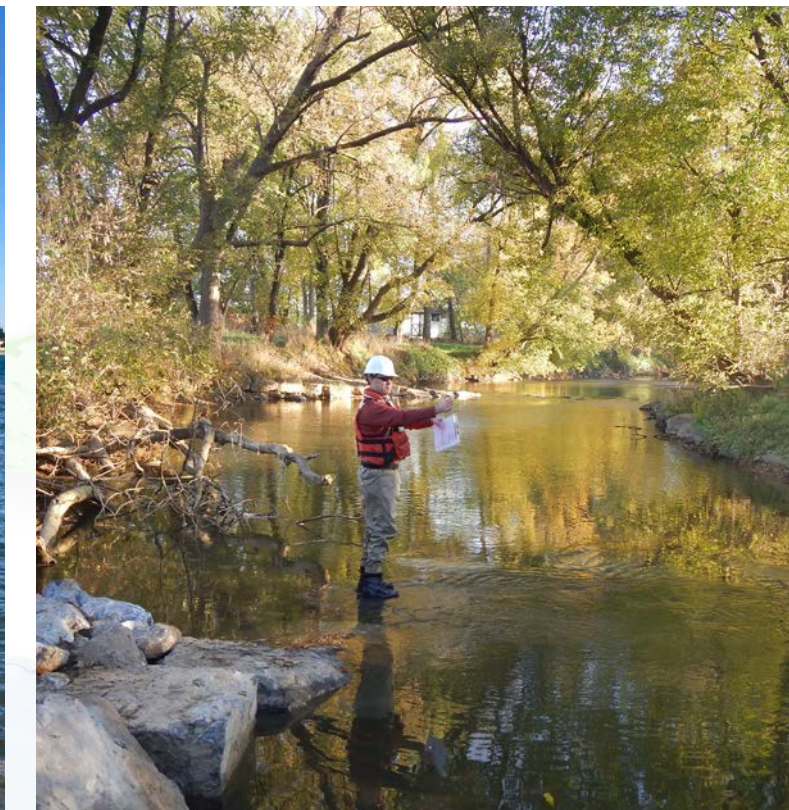



Fisheries Engineering

Kleinschmidt has provided biological and engineering fish passage consulting services for more than **150** projects located throughout the United States and Canada. We are widely respected for conceptual and final design work of fish passage facilities and biological assessments relating to fish passage and entrainment at hydropower facilities. Our **integration** of fisheries biologists, regulatory specialists, and engineers provides an exceptional capability for **solving problems** involving the **mitigation** of fisheries impacts and enhancement of fisheries resources.

- Species Restoration & Restoration Planning
- Feasibility Studies & Alternative Analysis
- Agency Consultation & Conceptual Layout
- Engineering Design
- Effectiveness Studies
- Fish Hatcheries



Water Resource Engineering & Habitat Restoration

Our water resource engineering team is composed of technical experts in hydrology, hydraulics and civil engineering who interact with our fisheries, aquatic and terrestrial scientists to provide **watershed** and **ecosystem-based solutions**. We offer a full spectrum of services beginning with detailed analyses and conceptual studies through design, project management, regulatory approvals and construction services.

- Restoration & Protection Design
- Dam Decommissioning & Removal
- Recreation Facilities Design
- Bridge & Culvert Hydraulic Design
- Watershed Planning
- Green Stormwater Design

GIS, Statistics, and Modeling

Kleinschmidt has provided modeling and geographic information system (GIS) services for more than 150 projects throughout the United States and Canada. Our **integration** of modelers and GIS specialists provides an exceptional capability for solving problems and communicating results. From the creation of a simple figure to a set of complex analyses on multiple variables, GIS allows complex tasks to be completed efficiently with dramatic results.

Kleinschmidt has also provided robust analysis and interpretation of temporal and spatial data related to water resources and engineering for hundreds of projects throughout the US and Canada. Our integration of statisticians, data scientists, modelers, and GIS specialists is unparalleled in the industry and is uniquely qualified for and exceptionally capable of designing solutions to quantitative challenges from the simple to the deeply complex. Our team strategically and efficiently uses the most up-to-date technology appropriate for your project objectives.

- Hydrologic & Hydraulic (H&H) Modeling
- 3D Modeling
- GIS Mapping & Cartography
- GIS Analysis & Data Science
- Remote Sensing
- Climate Change Analysis
- Statistics and Modeling
- Data Management

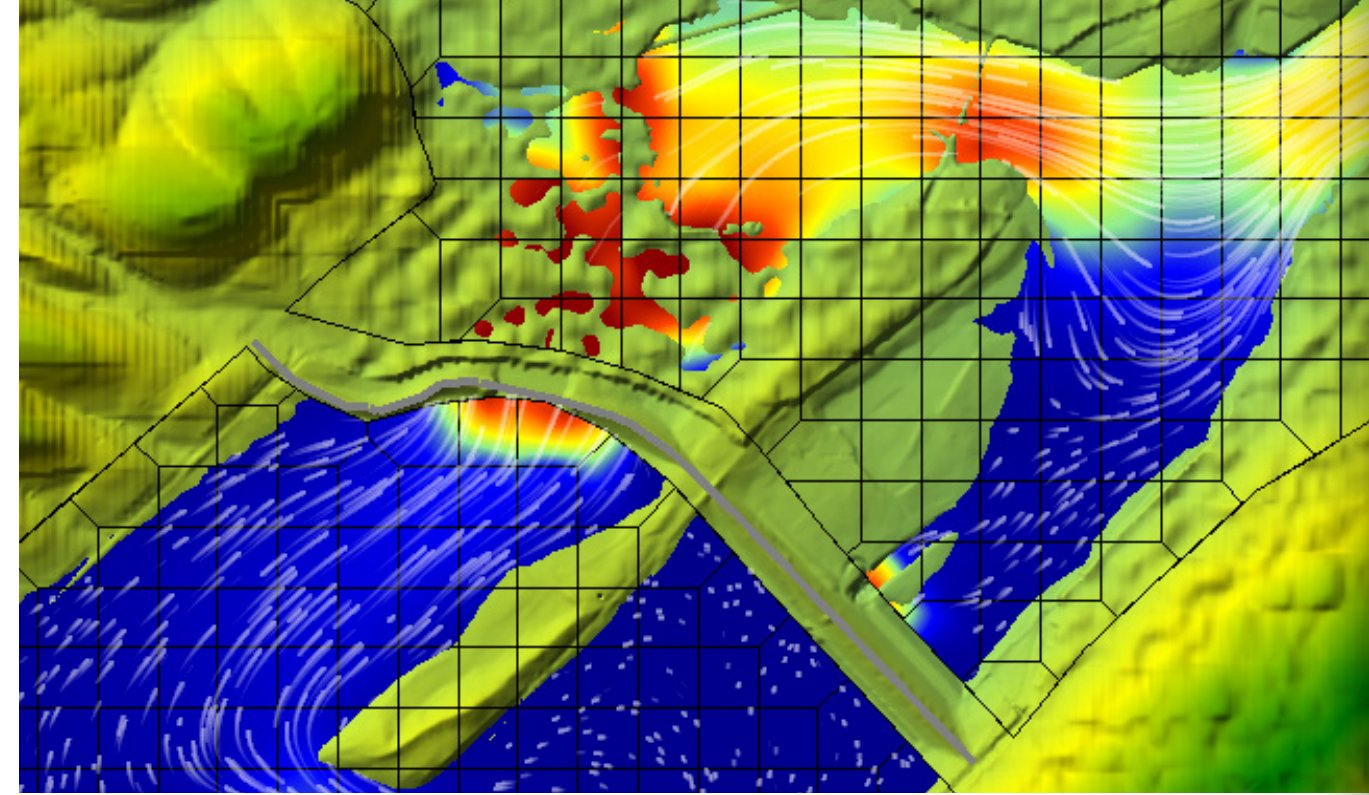

Come Make a Difference With Us!

Visit us on the web at
www.kleinschmidtgroup.com/grow-with-us/

Kleinschmidt

Kleinschmidt

Kleinschmidt

Kleinschmidt

Info@KleinschmidtGroup.com | KleinschmidtGroup.com

Maine –Corporate Office
Pittsfield, ME
207.487.3328

Connecticut
Essex, CT
860.767.5069

Pennsylvania
Strasburg, PA
717.687.7211

Southern Maine
Falmouth, ME
207.487.3328

Washington
Vancouver, WA
360.253.3483

Ontario, CN
Peterborough
905.706.5292

Alabama
Hoover, AL
205.588.4607

Oregon
Portland, OR
503.345.7956

South Carolina
Lexington, SC
803.462.5620

Washington
Redmond, WA
425.556.1288

Wisconsin
Madison, WI
608.819.2682

Nova Scotia, CN
Dartmouth
902.708.1082